



GAZEBO

*BUTTERFLY*



ASSEMBLY GUIDE

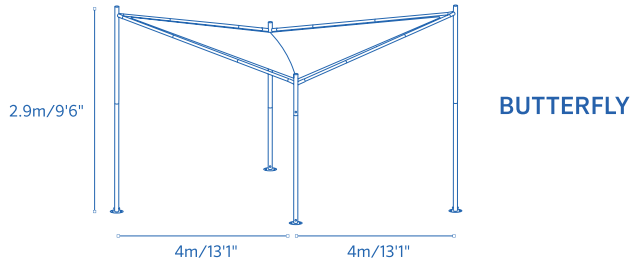

## STEP 1

Take all parts out of the box and ensure they are all present.

- a) & b) Upper corner poles x 2
- c) Cover poles x 4
- d) Lower leg poles x 4
- e) Feet x 4
- f) Common pole x 8
- g) Common bolts x 16
- h) Centre pole x 4
- i) Leg bolts with plastic caps x 4
- j) Lower leg pole bolts with plastic caps x 4
- k) Elastic bobbles
- l) Feet bolts x 12
- m) Spanner 1 (for lower leg pole bolts)
- n) Spanner 2 (for upper corner pole bolts)
- o) Turnbuckles
- p) Canopy

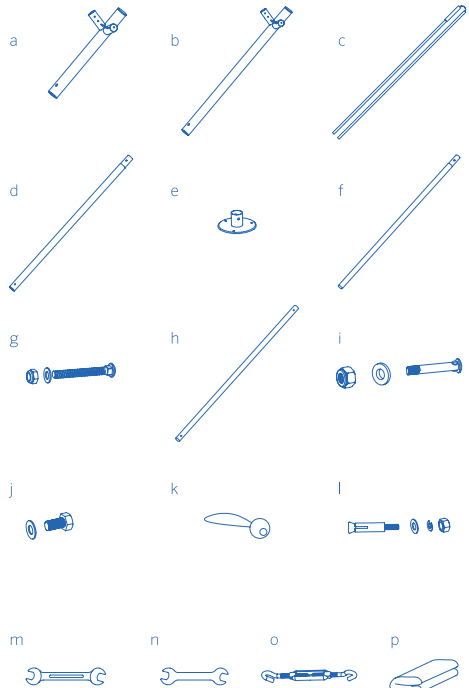

# ASSEMBLY GUIDE

## STEP 2

Measure a 4 x 4m square in the position you want the gazebo, mark the four corners with chalk or tape. Ensure the pole feet are placed on these markings with even spacing between poles to provide a sound structure.

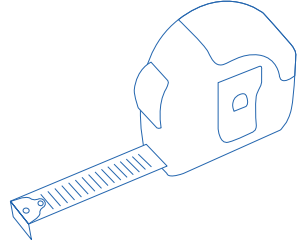

## STEP 3

Connect the common poles (f) using centre poles (h) as shown.

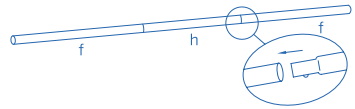

## STEP 4

Connect the common poles (f) into upper corner poles (a) and (b) as shown. Using spanner (n) provided secure with common bolts (g).

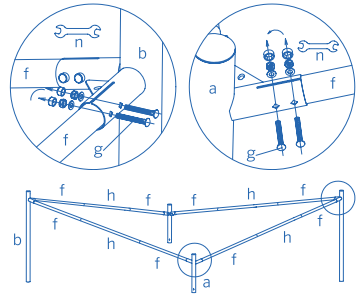

## STEP 5

Attach the feet (e) into lower leg poles (d) using bolts (j) and tool (m).

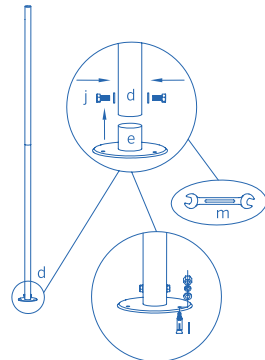

## STEP 6

Unfold the canopy (p).

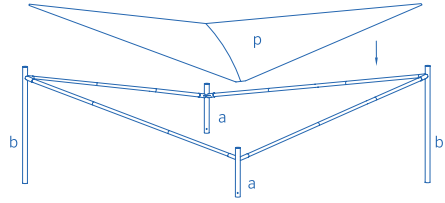

## STEP 7

Insert the four cover poles (c) along the edges of the canopy. Connect corners of the canopy to the corners of the frame with the turnbuckles (o).

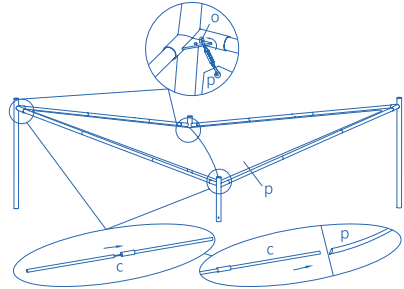

## STEP 8

Secure the edges of canopy to frame with elastic bobbles (k). Tighten the turnbuckles (o) by rotating.

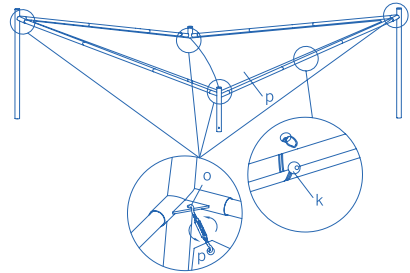

## STEP 9

Lift the assembled upper section of the gazebo and insert the lower leg poles (d) into the upper corner poles (a) and (b). Secure the connection with bolts and plastic caps (i).

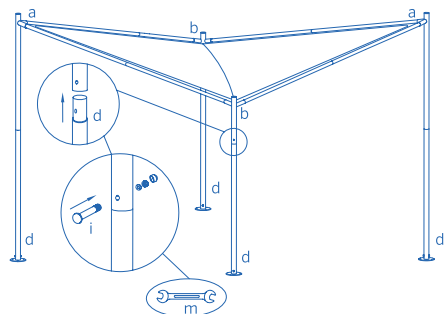

## STEP 10

Once erect, ensure the Butterfly gazebo is firmly secured to a stable surface, you can use feet bolts (l) if desired.



## The best under the sun

Coolaroo is the leader in shade fabric technology. Our extensive range of attractive shade solutions is carefully manufactured to protect your home, garden and family from the harsh sun.

[coolarousa.com](http://coolarousa.com)

### **WARNING**

When assembling and using this product, safety precautions should always be followed to reduce the risk of personal injury and damage to equipment. Please read all instructions before assembly and use.

At least two or more people are recommended for safe assembly.

Keep all children and pets away from assembly area.

Check all nuts and bolts for tightness before and during usage.

Non permanent structure. Do not use in extreme weather conditions including heavy rain or high winds.

Do not leave the gazebo unattended.

Do not place the product near an open flame; or too close to any heat source.

For help with product assembly or for any other questions you may have, contact our Customer Service Department.

Australia Toll Free: 1800 331 521  
New Zealand Toll Free: 0800 555 171  
United States Ph: +1 407 772 7900  
Middle East Ph: +971 4 881 7114  
China Ph: +86 574 5626 8888



Gale Pacific USA, Inc.  
PO Box 162625  
Altamonte Springs, FL 32716-2625, USA

Coolaroo is a registered trademark of Gale Pacific Limited



450540

# THANK YOU

## FOR PURCHASING A COOLAROO PRODUCT

Exposure to ultraviolet (UV) radiation from the sun is the major cause of skin cancer. In some countries the UV radiation is strong enough to cause sunburn in just 11 minutes on a fine summers day. To prevent sun damage we recommend following the Sun Smart steps: slip on clothing, slop on sunscreen, slap on a hat, slide on sunglasses and seek shade.

To register your product go to [coolaroo.com](http://coolaroo.com.au). The product code can be found printed above the barcode on the product packaging, alternatively you can find it on the relevant [coolaroo.com.au](http://coolaroo.com.au) product page.

### CARE & MAINTENANCE

When not in use for long periods of time dismantle the gazebo, and store in a dry place. If the canopy is wet, allow to dry naturally opened up before storing.

If necessary, clean the fabric with a hose.

Components subject to turning and sliding can be treated with a non-staining lubricant spray (silicon-based).

**Attention:** The schematics in this manual are for assembly and operation illustration only. They may differ from the gazebos actual appearance.